

Type (Modèle Usine) PS22/13140
Modèle WFGP70143VM
ID Produit / ART. No 739726

Marque HISENSE
Version 13. 08. 2021
N° d'Index 01

021447

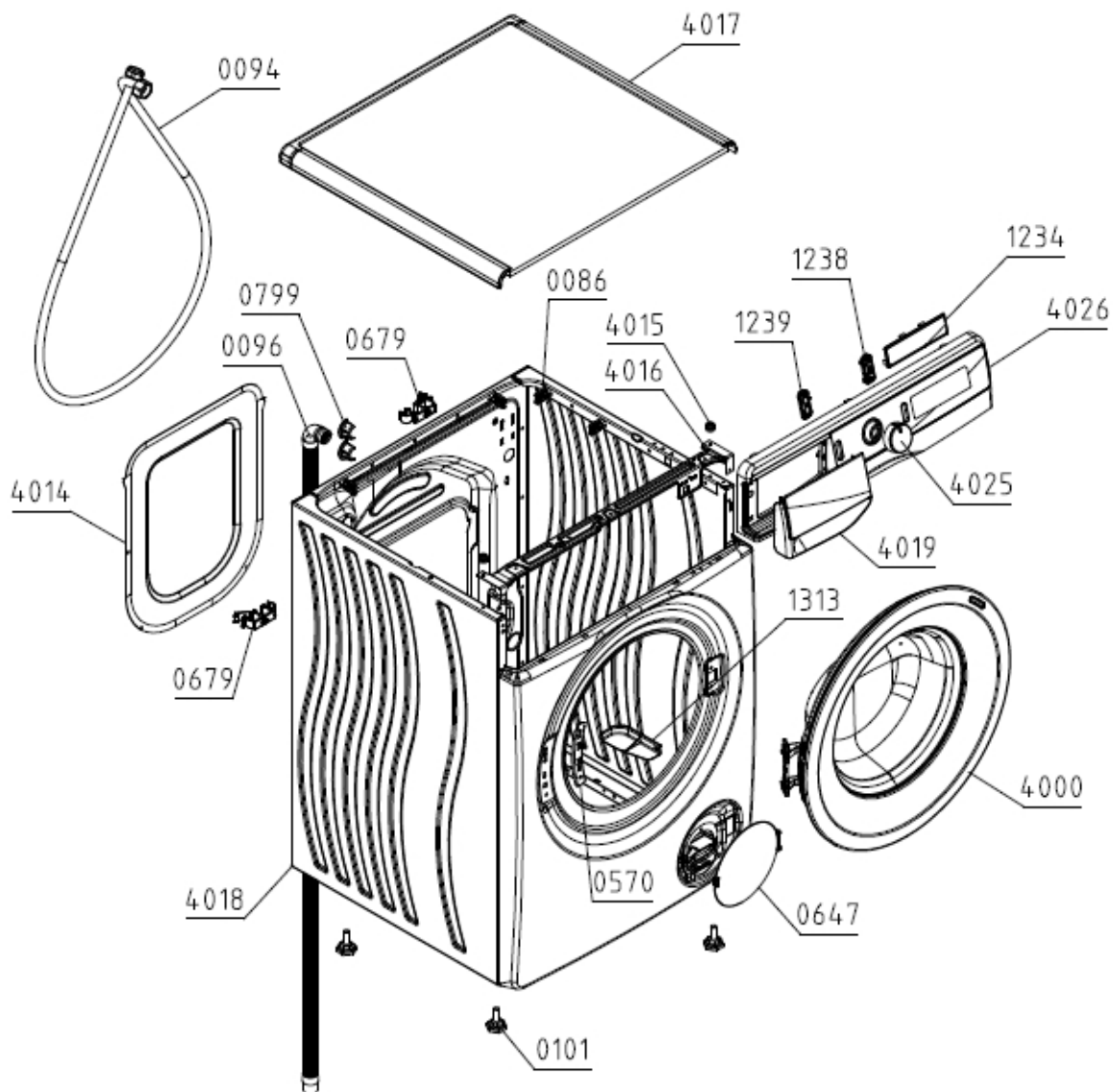

Position	Identifiant	Désignation	Quantité	Validité	Référence Pièce
0086	547104	CLAMP PS	12		G547104
0094	686969	SUPPLY HOSE H TUR KPL	1		G686969
0096	699606	DISCHARGE HOSE NK PS-15	1		G699606

Position	Identifiant	Désignation	Quantité	Validité	Référence Pièce
0101	816544	ADJUSTABLE FOOT PS-10 KPL	4		G816544
0570	466627	HINGE PLATE PS-15	1		G466627
0647	579303	FILTER COVER PS-15 KPL	1		G579303
0679	823979	HOSE HOLDER PS-20	2		G823979
0799	148999	RUBBER SEAL PS-03	1		G148999
1234	846693	DISPLAY PLATE B1 PS-22	1		G846693
1238	846677	PAUSE KEY PS/SP-22	1		G846677
1239	846676	SWITCH-ON KEY PS/SP-22	1		G846676
1313	829842	PROTECTION PMCU PS-20	1		G829842
4000	863875	DOOR PL.HINGE PS-15 BK ASSY	1		G863875
4014	466535	REAR WALL COVER PS-15 F	1		G466535
4015	578966	WORKTOP PLUG PS-15 ASSY	2		G578966
4016	808503	CONTROL PANEL HOLDER PS-15 MOLLIS	1		G808503
4017	579099	WORKTOP 54 PS-15 KPL	1		G579099
4018	714417	HOUSING 54-1600 PS-15 LA070-S	1		G714417
4019	865185	SOAP DISP.HANDLE IN-ST-7 PS-22 HSN SIG	1		G865185
4025	863443	CONTROL KNOB 9005 PS/SP-22 ASSY	1		G863443
4026	865094	CONTROL PANEL B1 PS-22 FR/NS HSN SIG	1		G865094

023457

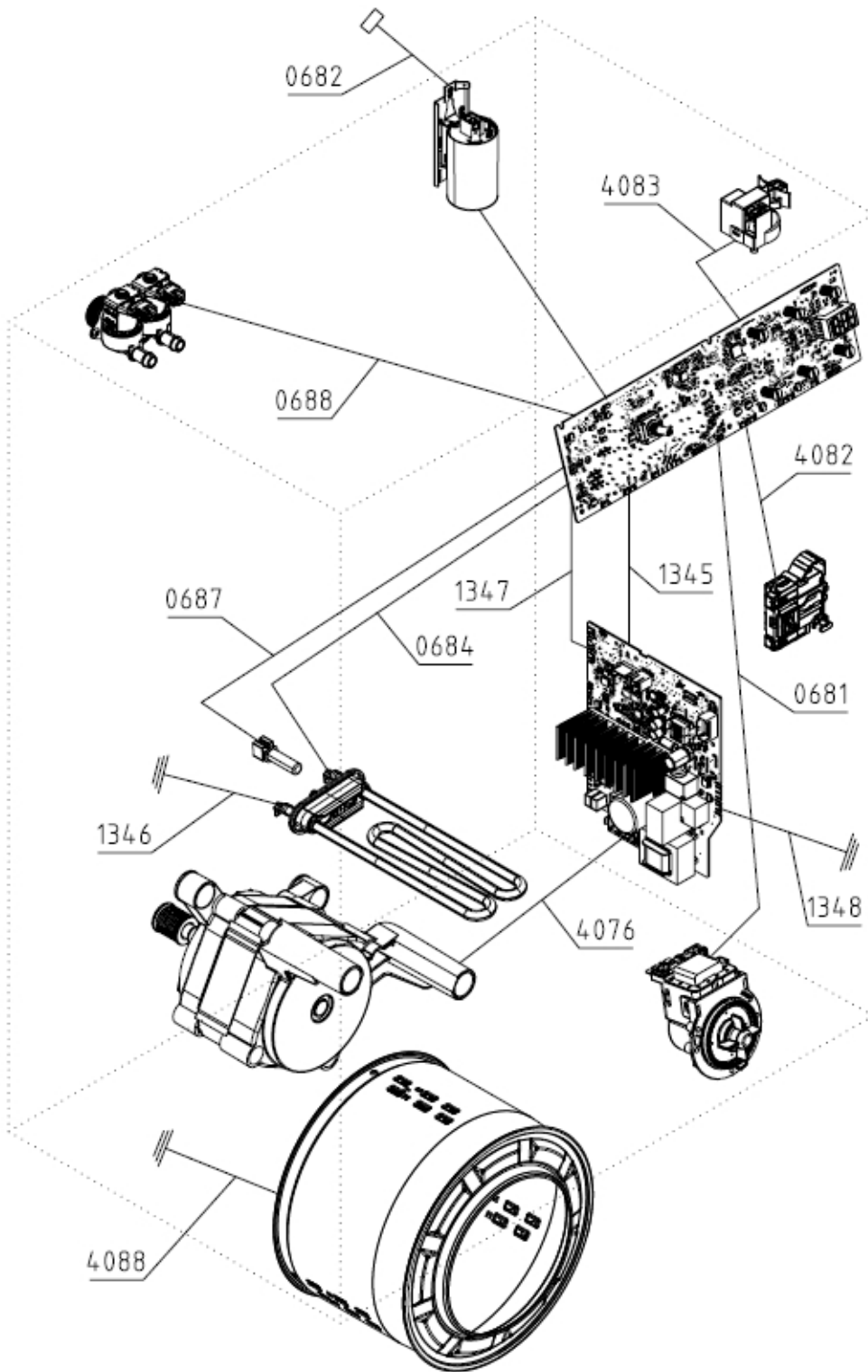

Position	Identifiant	Désignation	Quantité	Validité	Référence Pièce
0681	845744	WIRING HARNESS DRAIN PUMP 54/EN PS-22	1		G845744
0682	845674	WIRING HARNESS SUPPLY 54/EN PS-22	1		G845674
0684	845678	WIRING HARNESS HEATER 54/EN PS-22	1		G845678
0687	845729	WIRING HARNESS TEMP.SENSOR 54/EN PS-22	1		G845729
0688	845687	WIRING HARNESS VALVE 54/EN PS-22	1		G845687
1345	845696	WIRING HARNESS SUPPLY MCU-9 54/EN PS-22	1		G845696

Position	Identifiant	Désignation	Quantité	Validité	Référence Pièce
1346	845636	WIRING HARNESS EARTHING HEATER PS-22	1		G845636
1347	845721	WIRING HARNESS COMMUN.MCU-9 54/EN PS-22	1		G845721
1348	846301	EARTHING MCU-9 PS-22	1		G846301
4076	845613	WIRING HARNESS MOTOR EN PS-22	1		G845613
4082	845604	WIRING HARNESS DOOR LOCK EN PS-22	1		G845604
4083	845603	WIRING HARNESS LEVEL SENSOR EN PS-22	1		G845603

023458

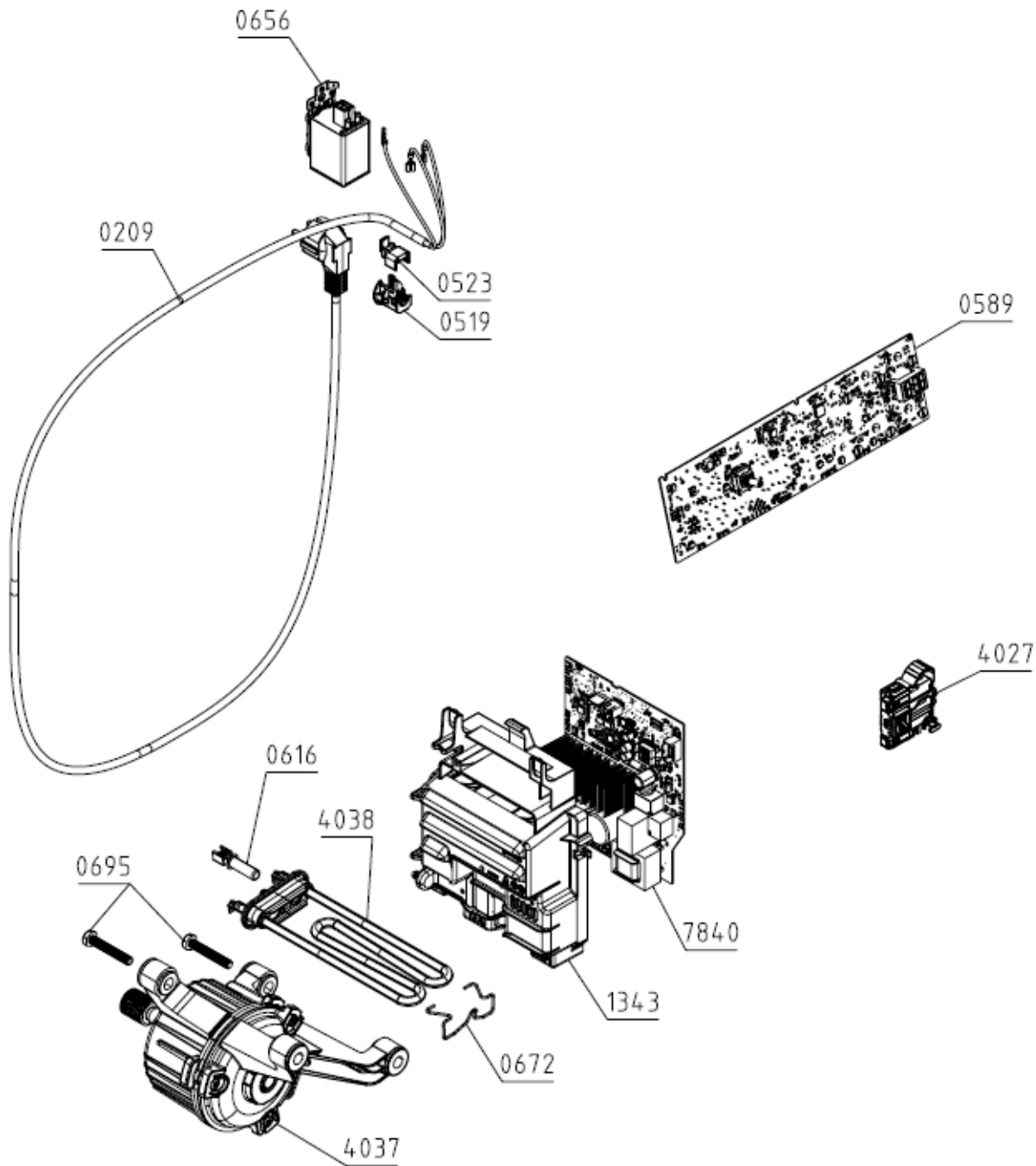

Position	Identifiant	Désignation	Quantité	Validité	Référence Pièce
0209	132222	CABLE WITH PLUG H05VV-F3G1.0 1550	1		G132222
0519	667400	RUBBER SEAL	1		G667400
0523	667401	CLIP FOR INITIATION SLEEVE	1		G667401
0589	860499	EK B1-BM22 PS-22/54-A-14-7-NS-E-M	1		G860499
0616	658696	TEMPERATURE SENSOR	1		G658696
0656	431466	RFI-FILTER 1,5MH H.A.L.	1		G431466
0672	194555	HEATER CLAMP PS-03 CA	1		G194555
0695	587311	SCREW PT80X50 EJOT A2K	2		G587311
1343	846697	CONTROL UNIT HOLDER MCU PS-22	1		G846697
4027	579333	DOOR LOCK PS-15	1		G579333
4037	806504	ELECTROMOTOR BPM 54 SANJIANG	1		G806504
4038	602720	TUB.HEATER 230V/1700W	1		G602720
7840	843134	SUPPLY UNIT BM-9.22 PS-22 SAN2	1		G843134

024418

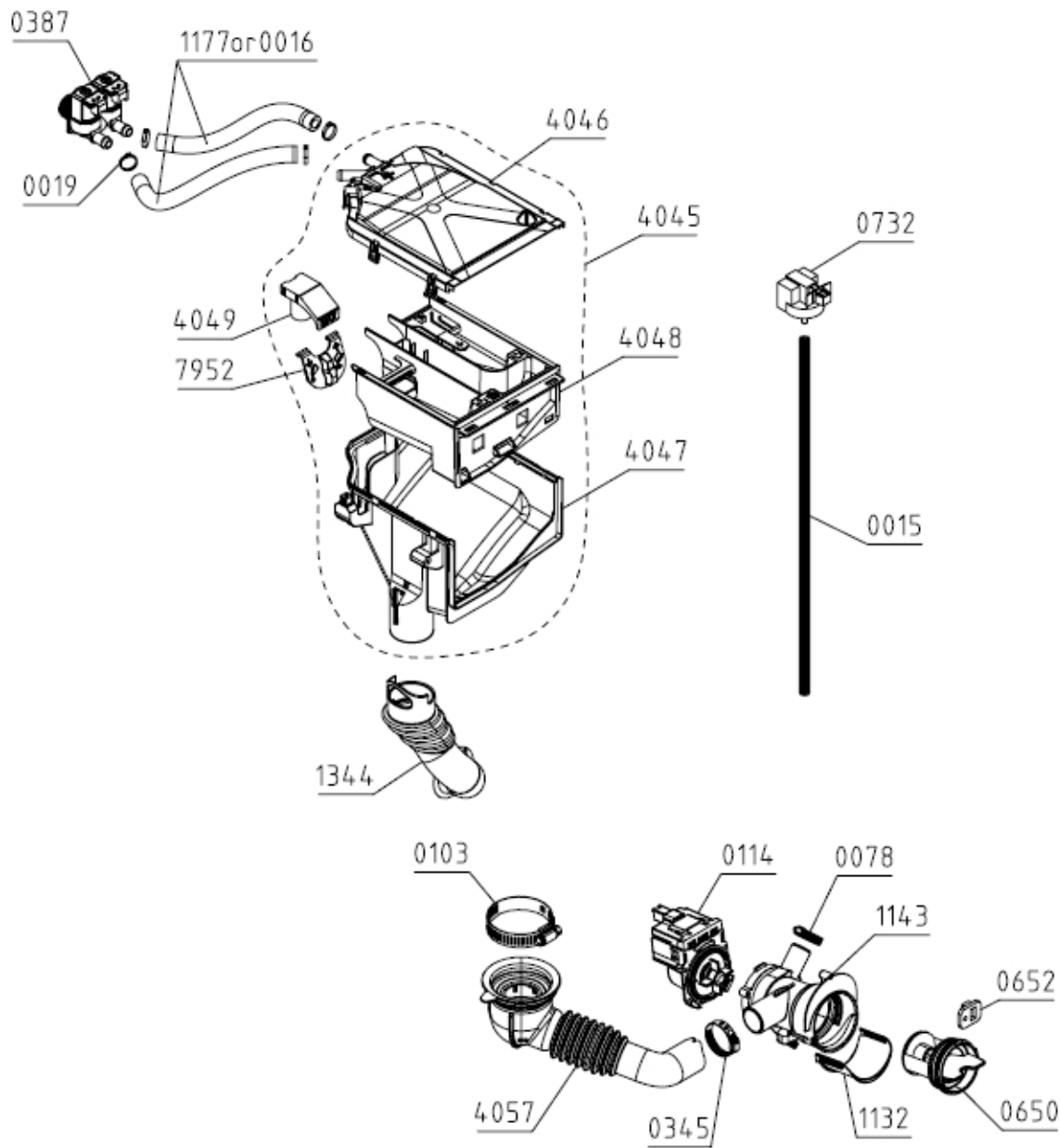

Position	Identifiant	Désignation	Quantité	Validité	Référence Pièce
0015	711818	HYDROSTAT HOSE PS-03 L555	1		G711818
0019	314400	CLAMP - PLASTIC D 16	4		G314400
0078	349484	CLAMP - WIRE D 28	1		G349484
0103	548401	CLAMP - WIRE PS D 65	1		G548401
0114	665323	DISCHARGING PUMP T2107 AL ASKOLL	1		G665323
0345	537874	CLAMP - WIRE D 38	1		G537874
0387	789799	ELECTRO VALVE DOUBLE MT ELBI	1		G789799
0650	716300	FILTER INSERTION E PS-15	1		G716300
0652	587438	FILTER SHOCK ABSORBER	1		G587438
0732	797414	WATER LEVEL SENSOR ST-545 NS METALFLEX	1		G797414
1132	333909	DISCHARGE CHANNEL PS-10	1		G333909
1143	333903	FILTER BOX PS-10	1		G333903

Position	Identifiant	Désignation	Quantité	Validité	Référence Pièce
1177	309930	HOSE PS D15X260	2		G309930
1344	838776	DETERGENT HOSE-TUB PS-20	1		G838776
4045	865351	SOAP DISPENSER SLIM BOL PS-15 ASSY	1		G865351
4046	579173	SOAP DISPENSER LID PS-15 KPL	1		G579173
4047	865318	SOAP DISPENSER HOUSING SLIM BOL PS-15	1		G865318
4048	579170	SOAP DISPENSER DRAWER PS-15	1		G579170
4049	466607	SOFTENER INSERT PS-15	1		G466607
4057	590300	HOSE TUB-FILTER PS-15 KPL	1		G590300
7952	466608	LIQUID DETERGENT INSERT PS-15	1		G466608

025406

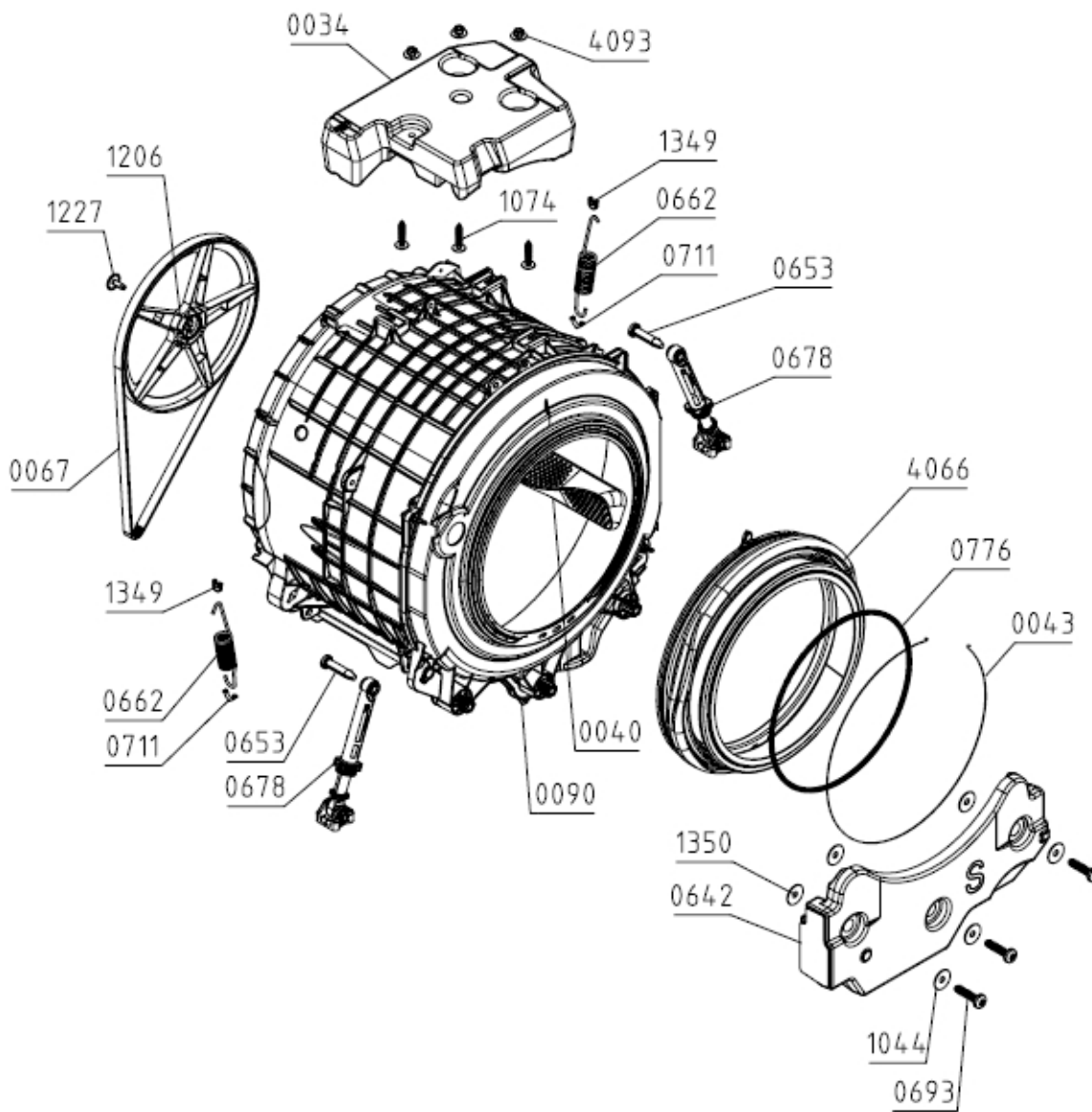

Position	Identifiant	Désignation	Quantité	Validité	Référence Pièce
0034	338878	COUNTERWEIGHT - UPPER PS-10	1		G338878
0040	664608	DRUM RIB WITH SHOWER 54 PS-15	3		G664608
0043	853975	WIRE CLAMP D350 ASSY	1		G853975
0067	727702	BELT 5EPJ 1260 GATES	1		G727702
0090	871979	TUB CA 54-1400 WITH DRUM PS-15/22-S	1		G871979
0642	338877	COUNTERWEIGHT - FRONT PS-10	1		G338877
0653	587313	TUB SHOCK ABSORBER PIN PS-03 000	2		G587313
0662	705599	TUB SPRING 54 PS-15	2		G705599
0693	587309	SCREW PT100X50-WN5452-50IP-EJOT-A2K-TORX	3		G587309
0711	587346	SUPPORT SPRING INSERT PS-03 040	2		G587346
0776	122062	SPRING CLAMP PS-03	1		G122062
1044	819493	DISC SPRING D34/D10,5	3		G819493

Position	Identifiant	Désignation	Quantité	Validité	Référence Pièce
1074	290070	SCREW	3		G290070
1206	682202	BELT PULLEY 45/54 PS-15	1		G682202
1227	712844	SCREW M8X24-12.9 BR	1		G712844
1267	560111	TUB SHOCK ABSORBER ASSY 54/60 PS-15	2		G560111
1349	857749	SUPPORTING SPRING INSERT-CABINET PS-21	2		G857749
1350	820573	WASHER 45X28X1,5-A2F	3		G820573
4066	576360	DOOR SEAL PS-15	1		G576360
4093	548358	NUT KPL	3		G548358